

# LOK-TEST and CAPO-TEST pullout testing, twenty years experience

By:  
Claus Germann Petersen  
B.Sc., M.Sc.

In-Situ Testing A/S  
Emdrupvej 102  
DK-2400 Copenhagen  
Denmark

Phone: +45 39677117  
Fax: +45 39673167

## Synopsis:

Experience during the past twenty years of pullout testing with Lok-Test and Capo-Test is given in terms of 26 major correlations to standard reference tests along with within-test and in-place variation. The theoretical and experimental investigations made into the failure mechanism are summarized. Pullout forces for Lok-Test are compared to Capo-Test.

The data shows a robust correlation not to be affected by variation in type of cement, w/c-ratio, age, curing conditions, air entrainment, admixtures, flyash, and shape/type and size of aggregates up to 40 mm maximum aggregate size. Only the use of lightweight aggregates produces a significantly different correlation. Pullout force by Lok-Test and Capo-Test is shown to be the same.

The stability of the correlations performed indicates general correlation(s) to exist, one to standard cylinder and one to standard cube strength. General correlations for normal concrete are suggested and compared for illustrative purpose to recent performed correlations. It is found that deviations on the strength estimate by the general correlation(s) deviate insignificantly from the actual performed ones, as long as identical concrete is used for the reference specimen and the specimen used for pullout testing.

It is concluded that general correlations can be used for normal concrete. Using such general correlations and for an average of 4 pullouts, the strength estimate of the coverlayer will, on a 95% confidence level, be well within plus/minus 3 MPa for 16 mm max. aggregate size and plus/minus 4 MPa for 32 mm in the range from 20 MPa to 70 MPa.

Lightweight concrete correlations are illustrated, along with a Capo-Test comparison with 100 mm x 100 mm 3-day air cured cores on old bridges for estimating the strength deeper into the structure than at the cover layer.

Finally, comprehensive references from 1970 to 1994 are given related to pullout testing with Lok-Test and Capo-Test and their applications, along with standards covering the methods.

**Keywords:** Pull-out test, compressive strength, coverlayer, durability, workmanship, curing conditions, early form-stripping, quality control.

Presented at the Non-Destructive Testing in Civil Engineering Conference in Liverpool, U.K., April 8-11th, 1997, organized by The British Institute of Non-Destructive Testing

## 1. Introduction

With Lok-Test (figure 1, left figure) a 25mm in diameter steel disc is embedded in the fresh concrete at a depth of 25 mm from the testing surface. At the time of testing, the disc is pulled against a counterpressure, 55 mm inner diameter, placed concentric with the disc on the surface, until rupture of the concrete occurs.

Similarly, for testing of existing structures, the Capo-Test (figure 1, right figure) utilizes a 25 mm ring, inserted and expanded into a recessed groove at a depth of 25 mm and pulled against a counterpressure as with Lok-Test.

Apart from the centerhole in the concrete, through which the pullbolt is attached to tile disc/ring, the test configurations for the two tests are identical. The centerhole in the Lok-Test disc is 11 mm in diameter. The same centerhole for Capo-Test is 18 mm.

In both tests the pullout force is measured and related to compressive strength by means of a calibration curve.

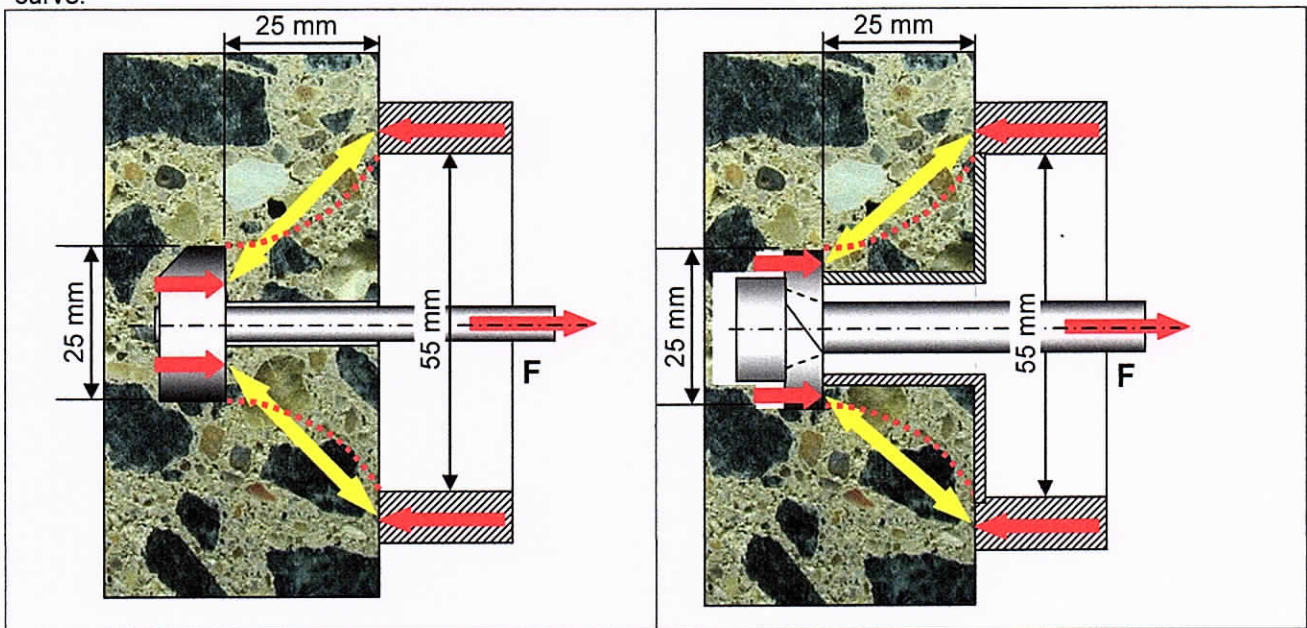

Figure 1. The Lok-Test (left) and the Capo-Test (right) testing shown schematically. With both systems a 25 mm in diameter disc/ring is pulled against a 55 mm inner diameter counterpressure placed on the surface until failure of the concrete occurs. The pull force is measured and related to compressive strength by a calibration curve.

The Lok-Test disc is embedded in the fresh concrete using special inserts attached to the formwork, or they are floated into the top surface. The Capo-Test disc (an expandable ring) is inserted in a prepared drilled and recessed groove, expanded and pulled out through a counterpressure as with Lok-Test.

## 2. Lok-Test development, 1962-1969

In 1962 Peter Kierkegaard-Hansen of Denmark came up with the design of the Lok-Test. His intention was to develop a test method that reliably indicated the quality of the coverlayer, to estimate the effects of the workmanship (composition, casting, compaction and curing) in addition to the potential strength as measured by cylinders and cubes at the ready mix plant, or at the site. The cover layer is, in terms of durability, a critical part, since it protects the reinforcement from harmful substances such as moisture, chlorides and carbon dioxide.

As most cover layers at that time ranged in dimension between 25 to 35 mm, the depth of the test was chosen as 25 mm, to make sure no reinforcement was present in the failure zone.

His innovative idea was to use a counterpressure to pull the embedded disc out against, and to measure the pullout force. At the Danish Engineering Academy's Building Division he conducted a series of tests where the inner diameter of the counterpressure was varied.

For a counterpressure of 130 mm he found the pullout strength to relate to about 10% of the compressive strength. For a 55 mm counterpressure the relationship was almost a 45-degree line, 1 kN pullout force being approximately 1 MPa compressive strength. For smaller diameter counterpressures the pullout force increased drastically.

Subsequently, in a series of tests he cast inserts in the bottom of cylinders, measured the pullout force exactly to failure and crushed the cylinders. For a strength range between 12 MPa to 40 MPa he found the correlation to be:

$$F_u \text{ (kN)} = 5 + 0.8 f_c \text{ (MPa)}$$

The coefficient of correlation was 0.97. The variation on the pullout force was 6%, and on the cylinders 5.6%. He concluded, that the property of the concrete measured by the pullout force for a 55 mm counterpressure was close to the one measured by standard cylinders. He called the test "Lok-Test", the Danish name of a "punch test".

### 2.1 Lok-Test correlations, 1970 to 1995

From 1970 to 1995, a total of 28 major correlations were made to investigate the stability of the relationship between pullout force and cylinder strength found by Kierkegaard-Hansen. The correlations cover a total of 4,362 Lok-Test's and 3,124 standard specimen compression tests, predominantly using one of following three procedures:

#### 1. Cylinder correlation procedure (Danish):

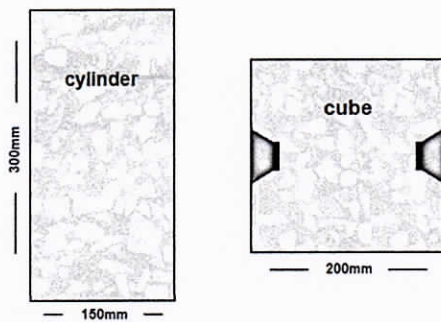

Compression tests made on 150 mm x 300 mm cylinders. Lok-Test's made on 200 mm cubes on opposite cylinder vertical faces, centrally placed.

Note: Same compaction and curing of the specimens is required as well as identical maturity at the time of testing.

Typically, 20-30 sets of specimens are made and comparative testing performed at 1, 2, 5, 14 and 28 days at 20 degree Celsius.

#### 2. Cylinder correlation procedure (North-American):

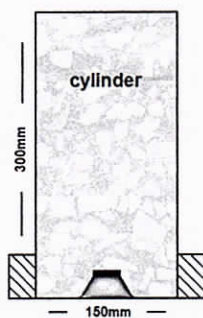

Lok-Test made exactly to failure followed by crushing of the cylinder.

Note: At higher strength levels a steel retaining ring is fitted around the bottom to prevent the cylinder to crack radially during pullout test. Accompanying cylinders without inserts are optionally used to make sure the pullout is not affecting the compressive strength.

Typically, 20-30 cylinders are made and comparative testing performed at 1, 2, 5, 14 and 28 days at 20 degree Celsius.

#### 3. Cube correlation procedure (Swedish/Dutch / English):

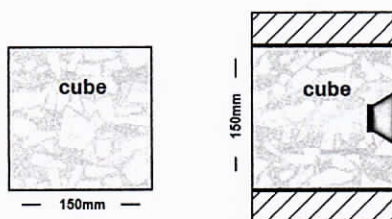

Compressive tests made on 150 mm cubes. Lok-Test's made on separate 150 mm cubes, at higher strength levels on 200 mm cubes.

Note: Same compaction and curing of the specimens is required as well as identical maturity at the time of testing. A steel retaining frame, as indicated, may be used to prevent the cube used for pullout to crack radially at higher strength levels for 150 mm cubes. Typically, 20-30 sets of specimens are made and comparative testing performed at 1, 2, 5, 14 and 28 days at 30 degree Celsius.

In addition, Lok-Test's have been compared to drilled-out cores on panels.

The parameters investigated have been: Type of cement, w/c-ratio, age, curing conditions (water cured, cured in air and maltreated), air entrainment, admixtures and flyash as well as shape, type and size of aggregate (up to 40 mm max. aggregate size). Only for the use of lightweight aggregates (page 14), was a correlation found other than those illustrated below.

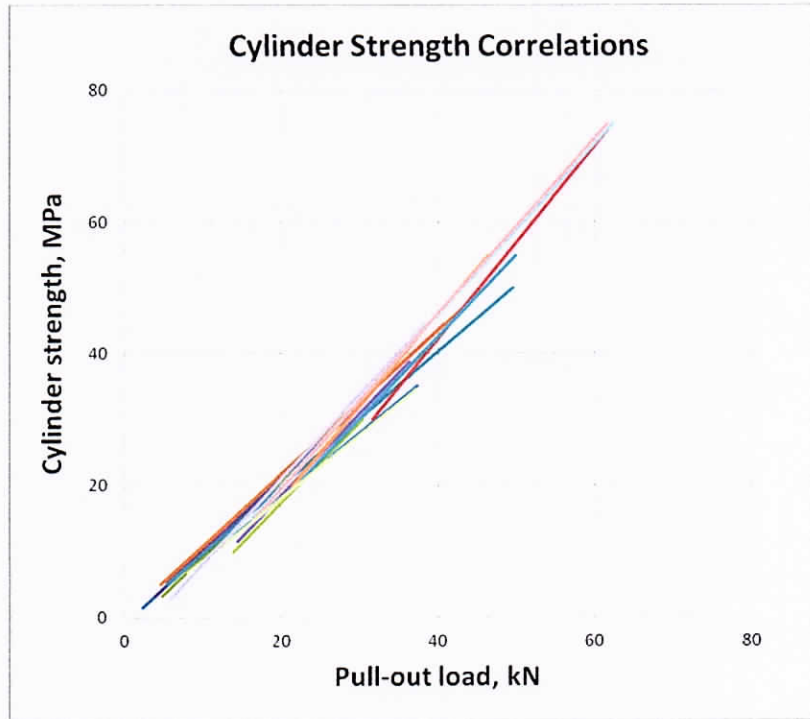

Figure 2. Sixteen correlations between Lok-Test pullout force and standard 150 mm x 300 mm cylinder compressive strength from Denmark, USA and Canada for normal types of concrete, ref Krenchel & Petersen, 1984.

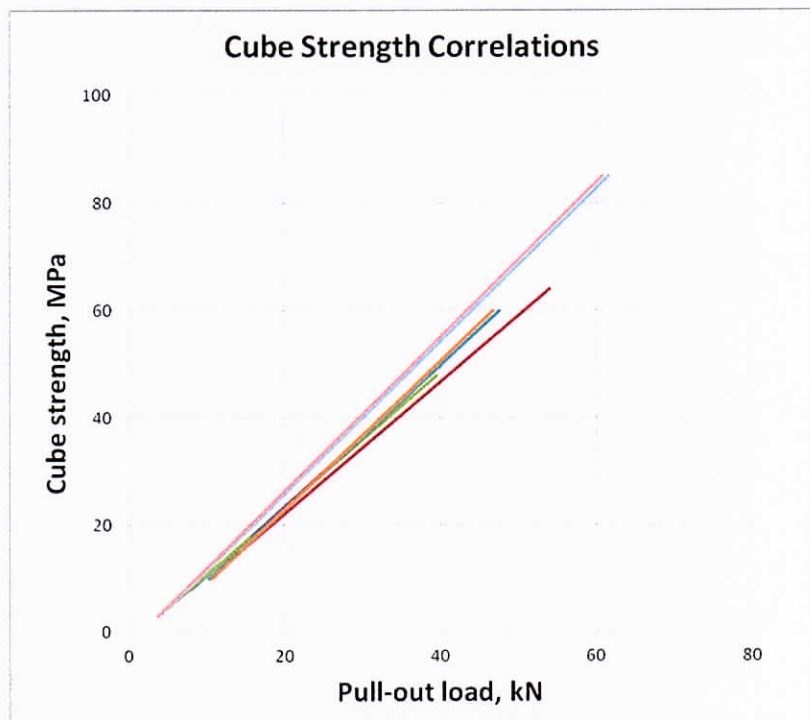

Figure 3. Ten correlations between Lok-Test pullout force and standard 150 mm cubes compressive strength from Sweden, England, Norway and The Netherlands for normal types of concrete, ref. Krenchel and Petersen, 1984.

The coefficient of correlation ranged from 0.91 to 0.99, typically 0.96.

The average within-test variations measured (the standard deviation "S" and the coefficient of variation "V") are for correlations # 1-16 and # 17-26 summarized in figure 4 along with the number of tests "n" performed:

variation	Lok-Test			Compression test		
	S (kN)	V (%)	n	S (MPa)	V (%)	n
Correlation procedure			-			-
Danish procedure	2.6	9.4	2188	1.6	4.2	1177
North-American procedure	1.9	7.5	994	1.7	6.4	994
Swedish/Dutch/English procedure	2.5	6.8	1180	2.4	6.2	953

Figure 4. Average within-test variations obtained in 26 correlations using the Danish, the North American and the Swedish/Dutch/English correlation procedures outlined sec. 2.1

For testing on-site the variation on the Lok-Test results are summarized in figure 5.

variation	Lok-Test		
	S (kN)	V (%)	n
Correlation procedure			-
Slabs, bottom part:	3.0	10.5	5320
Slabs, top part:	3.7	12.9	955
Beams and columns (middle):	2.8	8.1	677
Walls and foundations:	3.3	10.1	1020
Dubious structures:	4.5	14.7	1225

Figure 5. Average in-place variability of different elements/structures tested with Lok-Test. The first four categories cover new structures being either early form-stripped or quality controlled. Dubious structures are new structures with faults caused by e.g. incorrect casting, consolidation or curing. In general, an observation is min. two Lok-Test's made within one batch of placed concrete. However, in the first category, testing of slabs from the bottom, only one test is made in a batch, 10-15 inserts in 100 cubic meter of concrete (Bickley, 1982).

## 2.2 Lok-Test theoretical and experimental investigations, 1976-1985

In 1976, Bjame Christian Jensen and Mikael Bræstrup made the first investigation into the failure mechanism of a Lok-Test. For their analysis they used Coulomb's criterion of sliding failure. They concluded that: "The pull-out force is directly proportional to the compressive strength of concrete" (Jensen & Bræstrup, 1976).

In 1981, Niels Saabye Ottosen, published the results of a non-linear finite element analysis to explain the failure mechanism of a Lok-Test. His conclusion is: "that large compressive forces run from the disc in a rather narrow band towards the counterpressure. This constitutes the load carrying mechanism. Moreover, the failure is caused by crushing of the concrete, not by cracking. Therefore, the force required to extract the embedded steel disc is in direct dependence to the compressive strength of the concrete in question", (Ottosen, 1981).

The failure mechanism was further investigated experimentally by Herbert Krenchel in 1985. He loaded Lok-Test to different levels on the load-displacement curve. Afterwards, the samples were saw-cut through their axis, the surfaces were ground smooth and impregnated with epoxy containing a fluorescence dye to reveal cracks under ultraviolet light. The findings are given on the following page figure 6, 7 and 8, (Krenchel, & Bickley, 1985).

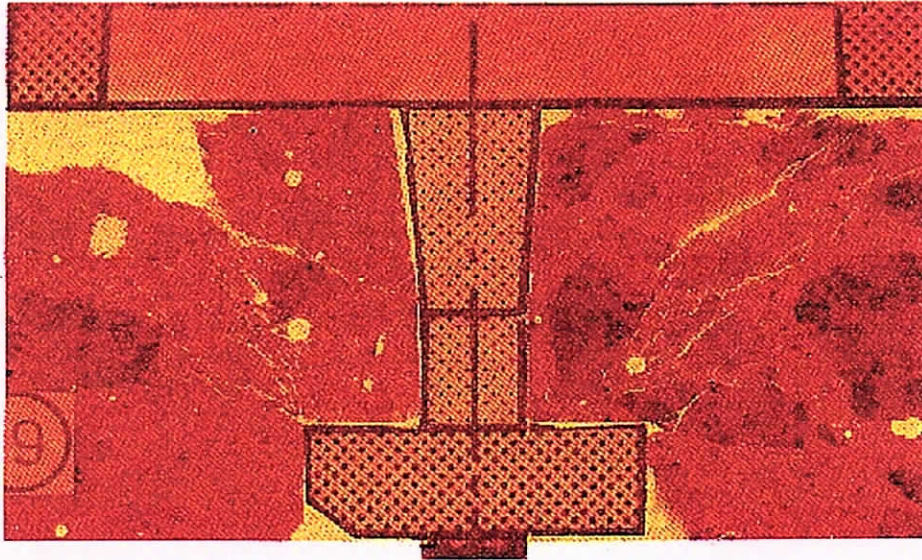

Figure 6. Crack analysis of Lok-Test de-loaded from the peak (#6) of the load-displacement curve shown in figure 8. The tensile cracking, stage no.1, has been formed as well as the multiple parallel microcracking, stage no.2. Stage no.3, the sliding crack, has not yet been formed.

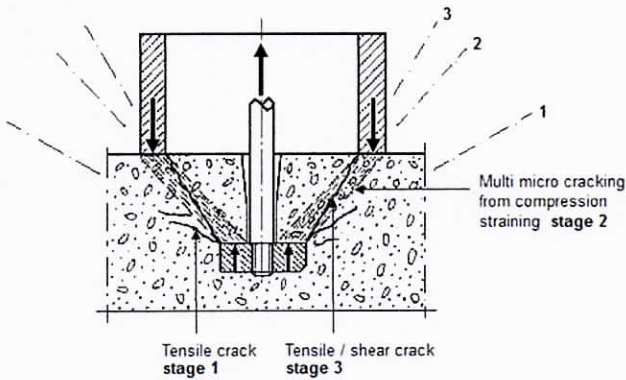

Figure 7. The three different stages of internal cracking during a Lok-Test.

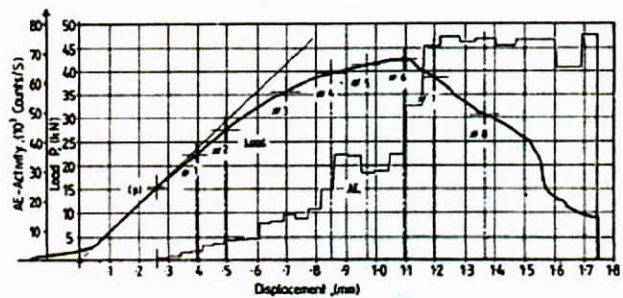

Figure 8. Complete load/displacement curve with AE-registration. Figure 6 illustrate the cracking at load level #6.

Krenchel describe the cracking during a Lok-Test as follows:

"The internal rupture during this type of test is a multistage process where three different stages, each with different fracture mechanisms, can be clearly separated. In the first stage, at a level of about 30-40% of the ultimate load, tensile cracking begins, starting from the notch formed by the upper edge of the pullout disc. This crack runs out in the concrete at a pronounced open angle (cone angle between 100 degrees and 135 degrees). The total length of this first crack is typically 15-20 mm from the edge of the disc. In the second stage of internal rupture, a multitude of stable microcracks are formed in the above mentioned truncated zone. The main direction of these cracks, running from the top of the disc to the bottom of the counterpressure, forms a cone angle of approximately 84 degrees. The formation of this second crack pattern is parallel to the formation of increasing vertical microcracks inside a concrete cylinder or cube during ordinary uniaxial compressive tests. Development of the acoustic emission activity during this second stage of the test also follow a function quite parallel to the AE-development of ordinary uniaxial compressive tests. If more and more oil is pumped into the pull-out machine, even after the load has stabilized at the peak point, the third stage of internal rupture occur. This forms a tensile/shear crack running all the way around from the outside edge of the disc to the inside edge of the counterpressure ring. The final--pull-out cone angle, which -can be seen when the cone is pulled out, is about 52 -degrees."

Krenchel concludes: *"Since the microcracking of rupture stage number two is responsible for and directly, correlated to the ultimate load in this testing procedure, it seems quite logical that such close correlations to the concrete compressive strength will always be obtained."*

### **3. Capo-Test development 1976**

Constant annoyance arose during the on-site use of Lok-Test in the early 1970's, since concrete structures could only be tested where inserts had been installed beforehand.

On one such occasion the author was ordered by Professor Mogens Peter Nielsen of AEC Consulting Engineers in Denmark to measure the compressive strength of the top layer of a deteriorating parking structure's roof-slab in Roskilde near Copenhagen. *"Chaps, you have to use Lok-Test, I don't care how you do it, just mail me the test results, ASAP!"* was his order.

First, the surface was planed, then a 35 mm core was drilled out from the underside of the 300 mm slab to a depth of 28 mm from the surface, and the bottom face planed with a diamond tool to an exact 25 mm distance from the surface. A center hole was drilled, a pullbolt inserted and threaded to a disc elevated through the cored 35 mm hole. Testing proceeded at a maximum speed of two Lok-Tests per day, for 3 technicians!

A more convenient test system evidently had to be developed, immediately.

The idea of the Capo-Test came partly from Lok-Test, and partly from the design of a piston ring in a combustion engine. Such a ring is split, widened out and placed in a piston groove. The Capo-Test utilizes the opposite principle. A ring is split by sideways cutting at one location, compressed and governed through a center hole into a 25 mm groove, 25 mm deep, where it is expanded. The groove is recessed through the center hole by a diamond tool with a similar shape as a dentist's drill, larger at the tip than at the base.

Development of the first primitive system took three days, and re-testing was performed adjacent to the Lok-Test's made with such great efforts, at the parking roof-slab in Roskilde. The pullout results exhibited in average a 1 kN deviation from the Lok-Test's, the shape of the failure cones was identical and one test with the new system only took 10 minutes!

The system was called CAPO-TEST (Cut And Pull-Out test).

#### **3.1 Capo-Test correlations and comparison to Lok-Test, 1976 to 1994**

Major correlations relating Capo-Test to compressive strength and comparing the findings with similar Lok-Test correlations were performed in 1982 in Denmark and 1983 in Sweden.

The Danish one (Krenchel, 1982) is reproduced in figure 9. Lok-Test and Capo-Test were made on 200 mm cubes, two of each tests centrally placed in opposite vertical faces, and compared to cylinder strength as outlined in the Danish procedure, section 2.1. Each point in figure 9 represent an average value of 2 cylinder results and 2 Lok-Test, respectively 2 Capo-Test. The correlation coefficient of both methods was found to be 0.95, and the coefficient of variation on the cylinders 3.6%, for Lok-Test 7.9% and for Capo-Test 7.8%, in average.

The Swedish one (Bellander, 1983) is shown in figure 10. Lok-Test and Capo-Test were made on 150 mm cubes as shown in the Swedish/Dutch/English procedure, section 2.1. At higher strength level a steel retaining frame was fitted to the 150 mm cube to prevent radial cracking during pullout. Each point is an average of 3 cube tests and 3 Lok-Tests, respectively 3 Capo-Tests. The correlation coefficient of Lok-Test / cubes was 0.98, of Capo-Test / cubes 0.97 and the residual standard deviation 2.0 MPa on both regression lines.

Furthermore, (Yun et al, 1988) and (Meyer, 1994) have published results comparing Lok-Test to Capo-Test. These comparisons are given in figure 11 together with Krenchel's and Bellander's.

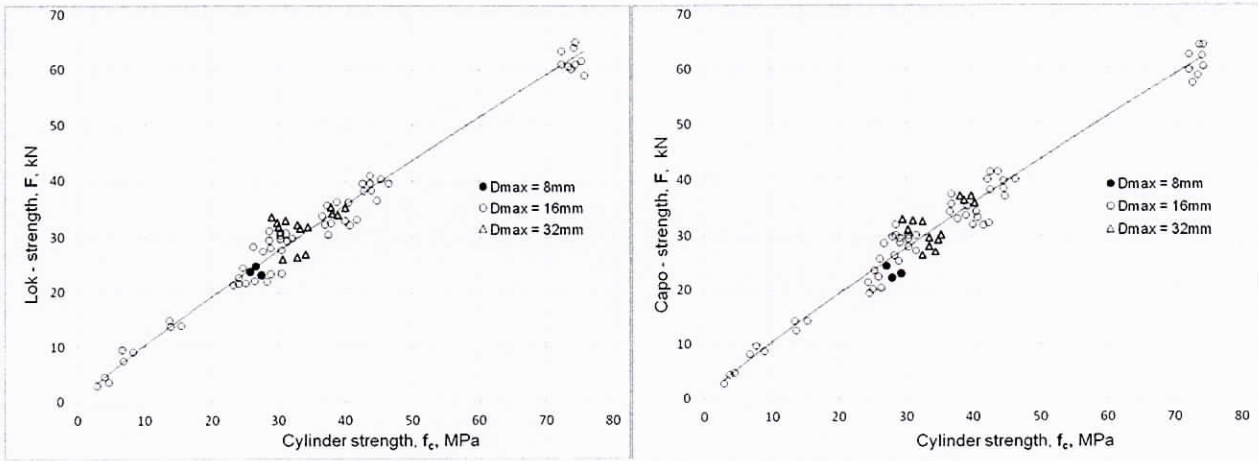

Figure 9. Danish comparative investigation made between Lok-Test / cylinder strength and Capo-Test / cylinder strength, cylinders being 150 mm x 300 mm standard cylinders (Krenchel, 1982)

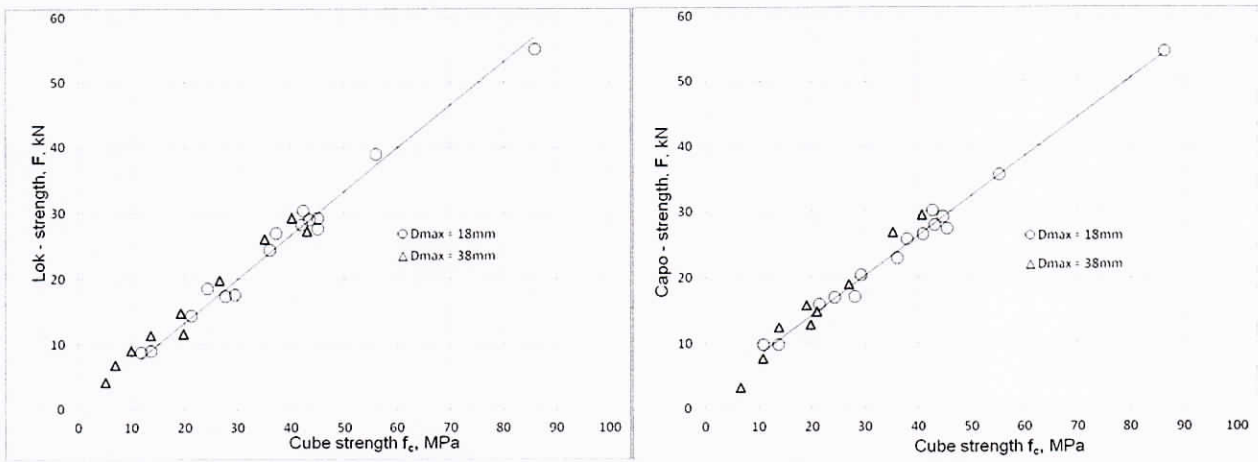

Figure 10. Swedish comparative investigation made between Lok-Test / cube strength and Capo-Test / cube strength, cubes being 150 mm x 150 mm x 150 mm standard cubes (Bellander, 1983)

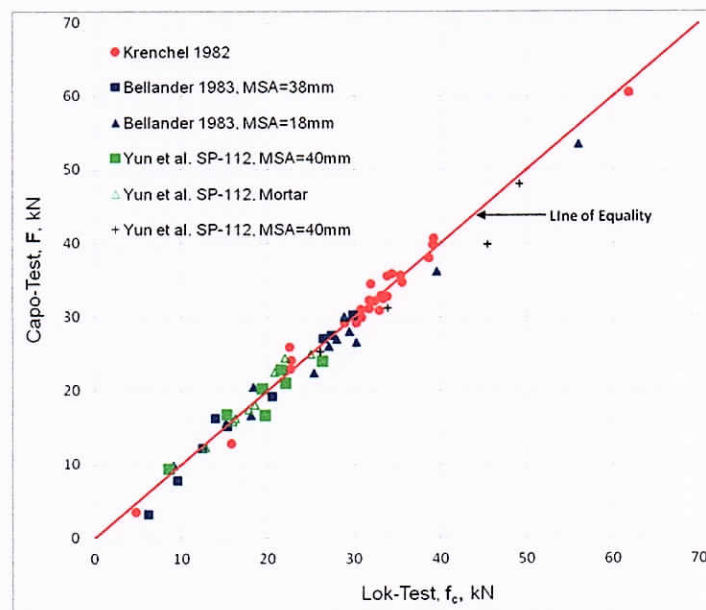

Figure 11. Capo-Test compared to Lok-Test (Krenchel, 1982), (Bellander, 1983), (Yun et al, 1990) and (Meyer, 1994)



As will be seen from fig. 9 and 10, the Capo-Test correlations resemble the Lok-Test's, almost identically, and the Capo-Test pullout forces are the same as the Lok-Test's, fig. 11.

Therefore, there is no reason to believe that the correlations are different than the previously established for Lok-Test, as well as the within-test variation.

On-site testing with Capo-Test made by the author's testing company has shown the following in-place variation during 15 years of operation:

variation	Capo-Test		
	S (kN)	V (%)	n
Correlation procedure			-
Slabs, bottom part:	3.2	7.1	35
Slabs, top part:	3.6	9.3	623
Beams and columns (middle):	3.1	8.0	434
Walls and foundations:	3.8	10.4	534
Dubious structures:	4.8	15.3	3334

Figure 12. Average in-place variation of different elements/structures tested with Capo-Test. The first four categories cover new structures being quality controlled. Dubious structures are new structures with faults caused by e.g. incorrect casting, consolidation and curing conditions, as well as deteriorating structures. In general, the practice has been to average two adjacent Capo-Test as an observation.

#### 4. Suggested general correlation to cylinder strength and examples of correlations

As shown in figure 2, the illustrated correlations show great stability for normal concrete. The following correlation is suggested as the general one for cylinder strength compared to pullout strength by LOK-TEST or CAPO-TEST:

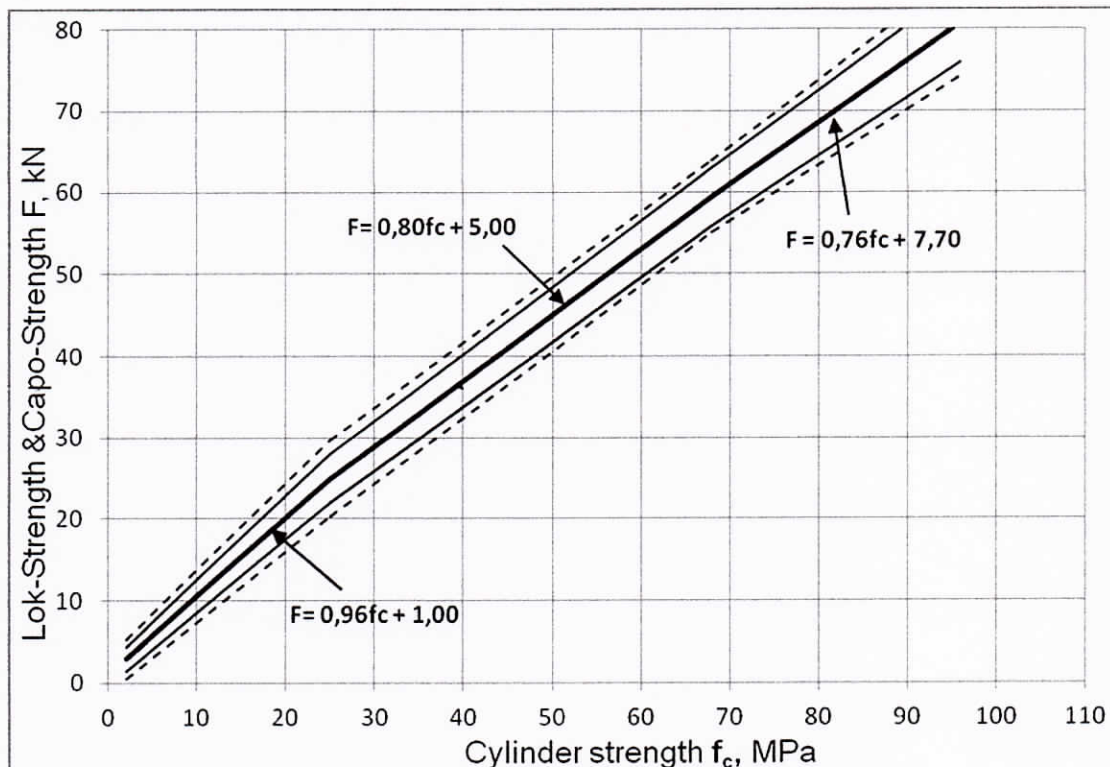

Figure 13. The suggested, general correlation between pullout strength measured by Lok-Test or Capo-Test and 150 mm x 300 mm standard cylinder compressive strength. The confidence limits are 95% limits for 16 mm (-) and 32mm (--) maximum aggregate size (Krenchel, 1970) for an average of 2 reference tests and 4 pullout tests.

Correlations in figure 2 are on a 95% confidence level within plus/minus 5% from the suggested general correlation.

## 4.1 Examples

Examples of correlations performed subsequently to the ones reported in fig. 2 and fig. 3, are illustrated in the following and compared with the suggested general relationship, one from USA made prior to an early form stripping project, and two produced in Denmark for quality control of the Great Belt Link's Western Bridge and Tunnel.

The North American one utilized the second procedure shown section 2.1 with Lok-Test inserts cast into the bottom of cylinders. Lok-Test's were pulled exactly to failure, and the cylinders were crushed in compression. A total of 32 cylinders were cast, moist-cured and tested at varying maturity. Maximum aggregate size was 32 mm. The measurements are plotted in figure 14 along with the regression line, and compared to the recommended correlation exhibited in figure 13.

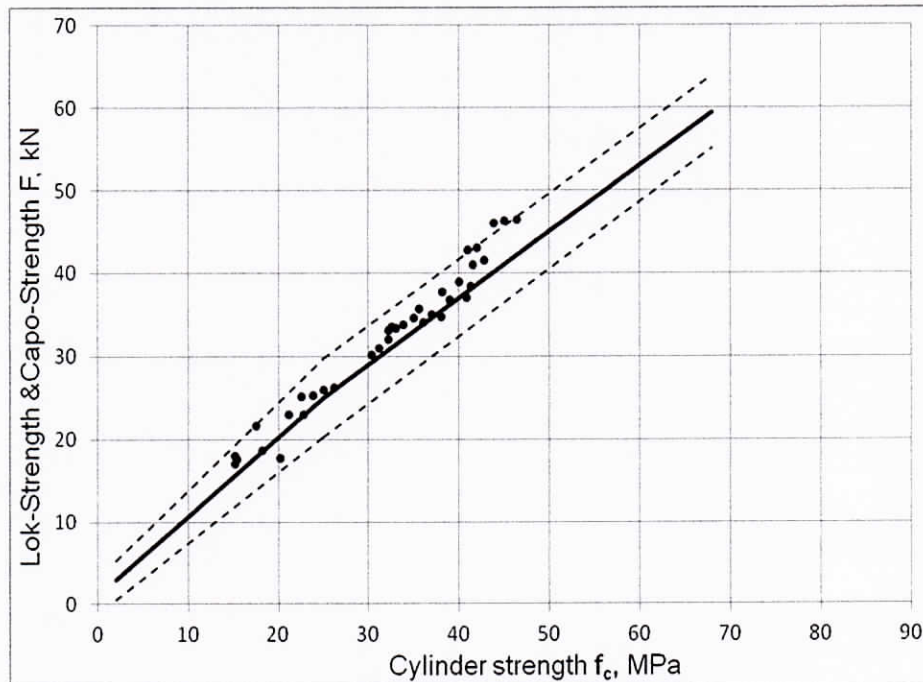

Figure 14. Comparison between the recommended correlation (figure 13) and comparative measurements made by CME, Buffalo, USA, between Lok-Test and standard cylinder strength made for two different mixes. Each point represents one Lok-Test result compared with one cylinder result.

The correlation was found to be:  $F \text{ (kN)} = 0.94 f_c \text{ (MPa)} + 1.20$  with a coefficient of correlation of 0.96. The within-variation on the Lok-Test was  $S_F = 1.77 \text{ kN}$  ( $V_F = 7.6\%$ ) and on the cylinders  $S_C = 1.45 \text{ MPa}$  ( $V_C = 7.3\%$ ). Had the general correlation been used, the deviation in the strength estimates would have been 1.1% different, on average.

The second example is from the Danish Great Belt Link's Western Bridge and Tunnel.

On the Great Belt Link, the Lok-Test and the Capo-Test was specified for quality control of the cover layer following trial casting testing at Herning, Denmark in 1988. On that occasion, pullout testing showed a 35% reduction in strength of the coverlayer as compared to standard cylinders and drilled-out cores at 28 days. Capo-Test conducted on the specimens after saw cutting of the specimens to a depth of 125 mm exhibited, however, strength close to the cylinders and cores. By means of microanalysis of the coverlayer, the reason was established to be caused by porosities and microcracking in the concrete surface stemming from drying out at an early age as well as thermal-cracking.

The correlations reported below were made by the contractors subsequent to the start-up of the project.

The specimens used for pullout testing were chosen by the contractors to be 200 mm x 200 mm x 400 mm prisms, not specimens as recommended in section 2.1.

The specimens were, for the tunnel correlation, vibrated with a poke vibrator.

For the Western Bridge it was not allowed to vibrate the 70 mm cover layer as it was believed the vibration would ruin the entrained air void system., and hence the freeze-thaw protection. Vibration was only made behind the reinforcement.

The specimens in the lab were similarly manufactured and cured in water at 20 degree Celsius together with the cylinders vibrated on vibration table. Lok-Test's were performed at the 200 mm x 400 mm side faces (two in each, giving 2 observations), while Capo-Test was conducted at the end- and bottom-faces (4 in each prism, giving 2 observations).

Three prisms and 9 cylinders were tested each at 3, 7, 28 and 56 days of maturity (Western Bridge) and 5, 14 and 28 maturity days (Tunnel).

The correlations obtained are shown in figure 15 along with the recommended correlation. The same type of concrete (type B concrete) was used for all correlations.

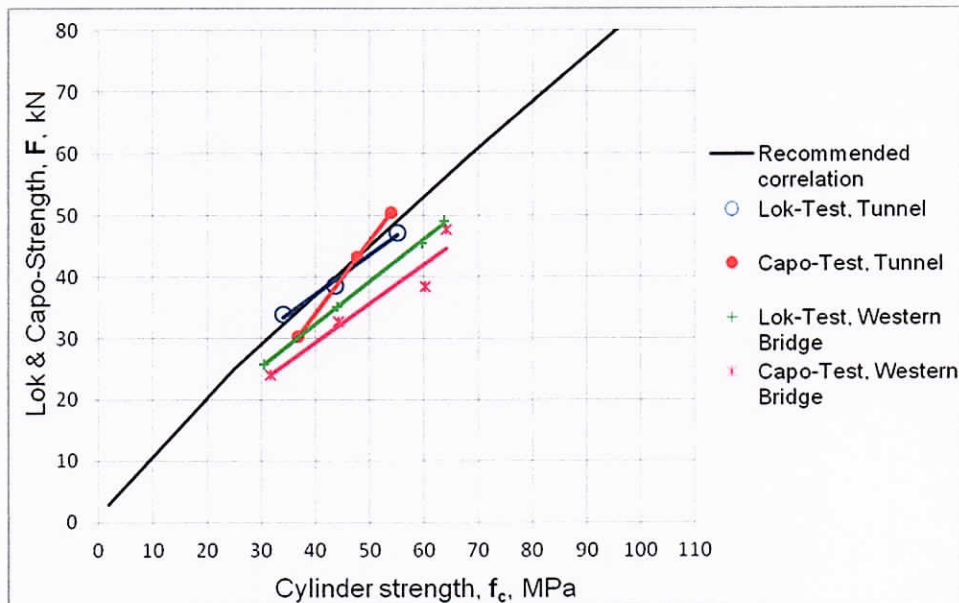

Figure 15. Correlations between Lok-Test/Capo-test and cylinder strength used on the Great Belt Link's Western Bridge, the Tunnel and the East Bridge

As will be seen, the Western Bridge's correlations deviate on average 20% from the recommended one, while the Tunnel's are not significantly different from the recommended.

The Tunnel contractors correlations suffer obviously from limited amount of clusters and a lack of a sufficient span, hence the rather arbitrary slopes.

As far as the Western Bridges correlations are concerned, Meyer believed the difference to be caused by a relatively high content of powder in the concrete and its low w/c-ratio, (Meyer, 1994). This explanation is, however, not substantiated by the tunnel contractor's correlation, where the same concrete mix was used. Furthermore, correlations made by Krenchel in 1970 also covered concrete with a w/c-ratio of 0.35, and he found no deviation from the recommended one for low w/c-ratios (Krenchel, 1970).

Another explanation for the deviation can be different compaction of the cylinders and the prism's in an attempt by the contractor to have the structure accepted, a structure where no vibration was made of the cover layer.

### Suggested general correlation for cube strength and example of correlations

As for cylinders, the correlations between pullout force and 150 mm cube compressive strength exhibit stability for normal concrete as illustrated in figure 3. Obviously, the relationship is slightly non-linear, as with the cylinder correlation.

Figure 16, following page, illustrates the mean-correlation, which on a 95% confidence limit is plus/minus 6% apart from the correlations in figure 3.

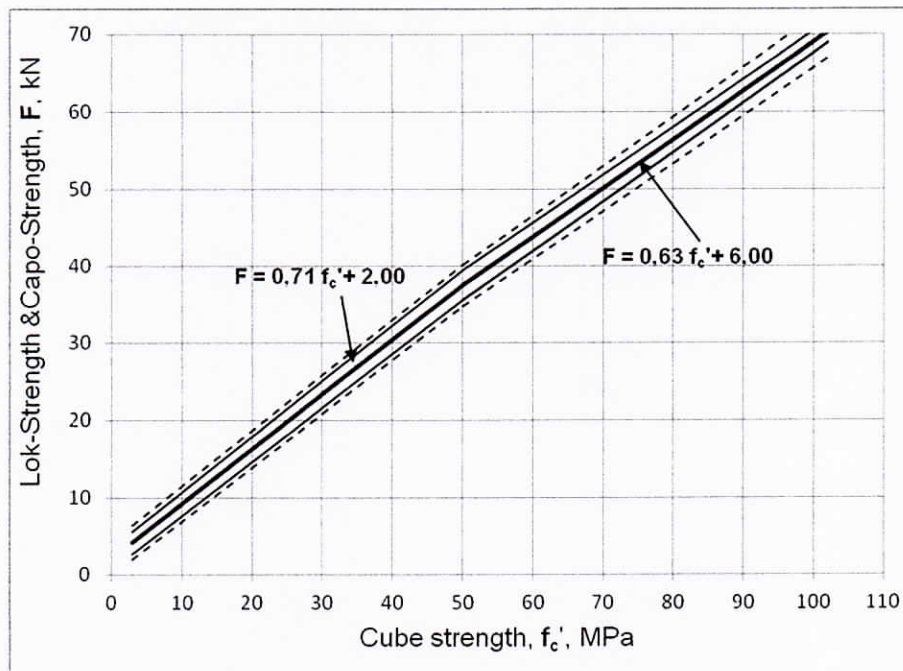

Figure 16. The suggested, general correlation between pullout strength measured by Lok-Test or Capo-Test and 150 mm standard cube compressive strength. The confidence limits are 95% limits for 16 mm (-) and 32 mm (-) maximum aggregates size (Krenchel, 1970) for an average of 2 reference tests and 4 pullouts.

### 5.1 Examples

Two examples are given below to substantiate the validity of the suggested, general relationship for cubes, one from Luxembourg made for quality control, and one from The French-British Channel Tunnel used for approval of precast tunnel segments quarantined for quality reasons during production.

In the calibration from Luxembourg the 3rd procedure in section 2.1 was utilized with Lok-Test's embedded in 200 mm cubes, two Lok-Test's in each cube for comparison to cube strength. A total of 26 sets of specimens were manufactured on vibration table, water-cured and tested at varying maturity. The maximum aggregate size was 32 mm. The findings are illustrated in figure 17.

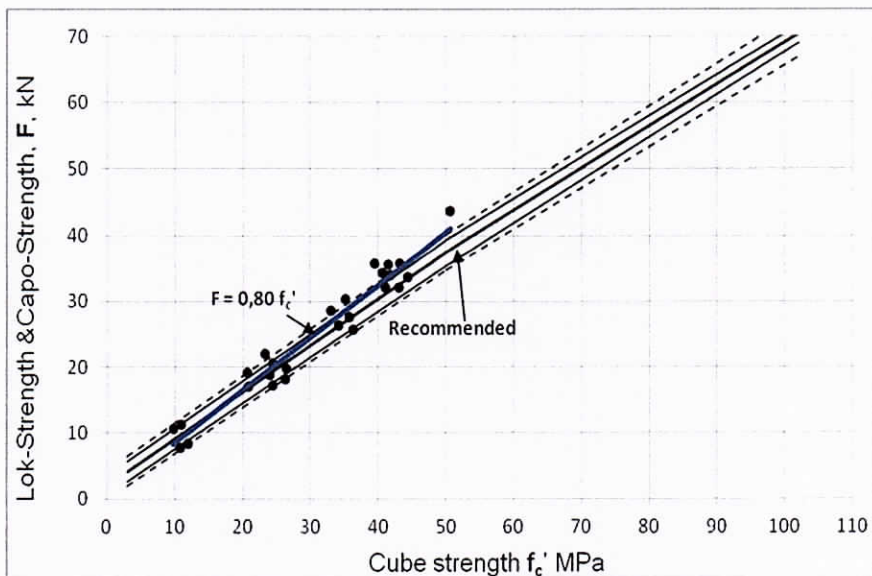

Figure 17. comparison between the recommended-correlation (figure 16) and measurements made by Pont et Chaussées, Luxembourg, between Lok-Test and standard cube compressive strength. Each point represents an average of two Lok-Test's and one cube result.

The correlation is  $F = 0.8 f_c'$ , and the coefficient Of correlation 0.95. The within-test variation on the Lok-Test was  $S_F = 2.9 \text{ kN}$  ( $V_F = 9.9\%$ ) and on the cubes  $2.3 \text{ MPa}$  ( $V = 7.1\%$ ), on average.

Using the strength correlation produced the average deviation of estimated strength from the general correlation is 1.5 %.

The second example is from the French-British Channel Tunnel. A correlation project was carried out prior to using Capo-Test for acceptance testing of the precast segments produced at the Isle of Grain plant in the U.K. A number of segments had been quarantined during production as a result of the quality assurance scheme in force. If the discrepancies were relatively minor and fitness for use could be proved, then segments were re-instated. CAPO-Test was introduced as a cost-effective replacement for conventional coring. Using the coring method meant that any segment cored had to be discarded. The use of Capo-Test allowed the tested segment to be patched in the CAPO-TEST cone holes and used, and also permitted a much greater frequency of testing.

The correlation was performed according to the 3rd procedure outlined in section 2.1. Eight sets of cubes were produced, each set consisting of 4 cubes. Compaction was made on vibration table and curing in water at 20 degree Celsius. Of each set, two of the cubes were tested with Capo-Test while the cubes were still in their steel moulds (to prevent radial cracking), and the other two were tested in compression. Testing was performed at 4, 7, 28, 154 and 329 maturity days. Two sets were tested at the first three maturity ages, while one set was tested at the last two maturity ages. In figure 18 each comparative measurement (●) represents in this manner an average of two Capo-Test's and two cubes, 8 points in total.

Additionally, segments with 4, 7 and 28 maturity days were tested with Capo-Test (4 Capo-Test in each) and compared to two production cured cubes. Two segments were tested at each maturity age. In figure 18 the 6 points labeled (o) represents an average of 4 Capo-Test's and two cubes (Worters, 1990).

The maximum aggregate size was 20 mm.

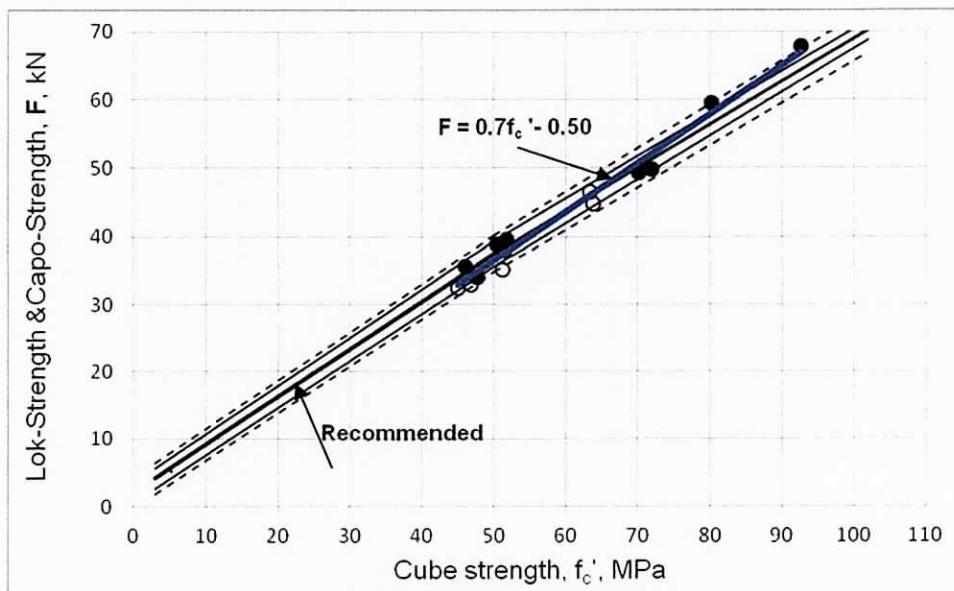

Figure 18. Comparison between the recommended correlation (figure 16) and comparative measurements made at the TML site in U.K. between Capo-Test on cubes compared to standard cube strength (●) and Capo-Test on elements compared to production cured cubes (○).

The correlation was found to be  $F = 0.71 f_c' - 0.5$  and the coefficient of correlation 0.98. The residual deviation is 1.9 MPa. Had the recommended correlation been used instead of the produced one, an average deviation on the strength estimate of 0.8% would have been achieved.

The quarantined segments were subsequently tested with Capo-Test, 3 in each element, and the segments were - as far as the author was informed - all accepted for use in the tunnel.

## 6. Correlations deviating from the suggested general correlations

From the discussion and examples shown on previous pages, the experience, so far, is that the correlations between pullout force measured by Lok-Test /Capo-Test and reference compressions tests on standard cylinders / cubes show great stability for all types of normal concrete, provided the same quality of concrete is used in the reference specimen and the specimen for pull-out.

The Lok-Test and the Capo-Test are quite sensitive methods that react to even smaller differences in concrete quality, e.g. caused by changing compaction and curing conditions.

Therefore, it is absolutely imperative that the same concrete quality is tested for correct comparisons to be obtained.

It is also imperative that the technicians are well-trained in the methods and able to evaluate the validity of the tests from the nature of the failures obtained, of the pullout tests as well as of the reference tests (Petersen & Poulsen, 1992).

Two sets of investigations have, however, shown correlations significantly different from the ones indicated, one is related to concrete with lightweight aggregates, another concerns strength investigation of old structures using Capo-Test.

### 6.1 Correlations for lightweight aggregates

Calibrations have shown no effect from varying type, shape and size of maximum aggregate size, only the variation increase on the pullout test result as the maximum aggregate size increases (Krenchel & Petersen, 1984). Even for mortar, the correlations performed (to 150 mm x 300 mm cores) by (Yun et al, 1988) show no significant deviation from the general one as indicated in figure 19.

However, for lightweight aggregate another correlation has been found, reported in a supplementary investigation by (Krenchel, 1982) and by (Nasser, 1988).

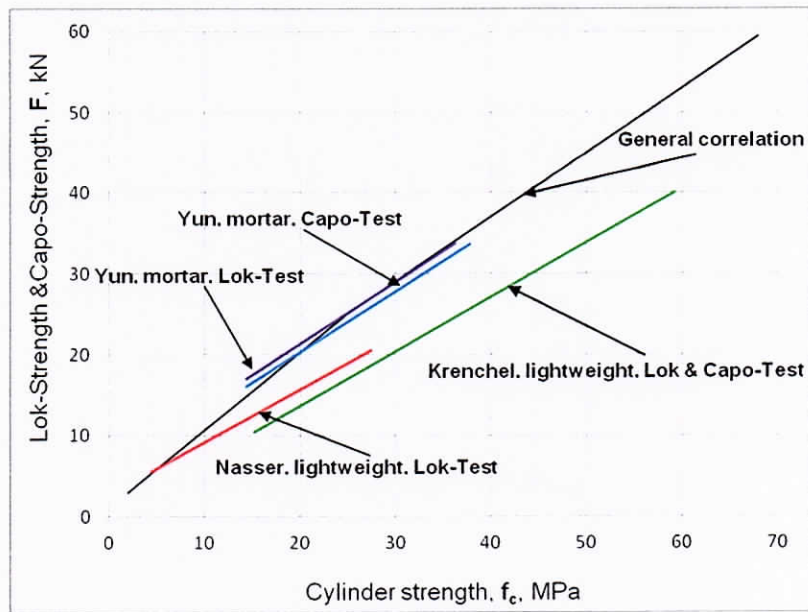

Figure 19. Lightweight concrete correlations by (Krenchel, 1982) and (Nasser, 1988) compared to mortar correlations by (Yun et al, 1988) and the general correlation for cylinder strength

The variation on the mortar was for Lok-Test 4.5 % and on the Capo-Test 7.1 %.

On the lightweight concrete the variation on the Lok-Test was found to be 5.1% and on the Capo-Test 5.5%.

## 6.2 Correlation between Capo-Test and 100 mm x 100 mm cores on old structures

The National Swedish Testing Institute (SP) made from 1981-1985 a correlation investigation on 13 Swedish bridges with an age up to 63 years old. Capo-Test's were made on circular columns in the 25 mm top surface and compared to cores, 100 mm x 100 mm, drilled out adjacent to the Capo-Tests.

The cores were trimmed and air-cured three days before testing.

In this manner the strength of the 25 mm top surface layer of the columns was compared to strength of the concrete about 75-100 mm deep into the structures.

The correlation obtained (Rockström and Molin, 1989) is shown in figure 20 together with the general correlation for standard cubes for comparison.

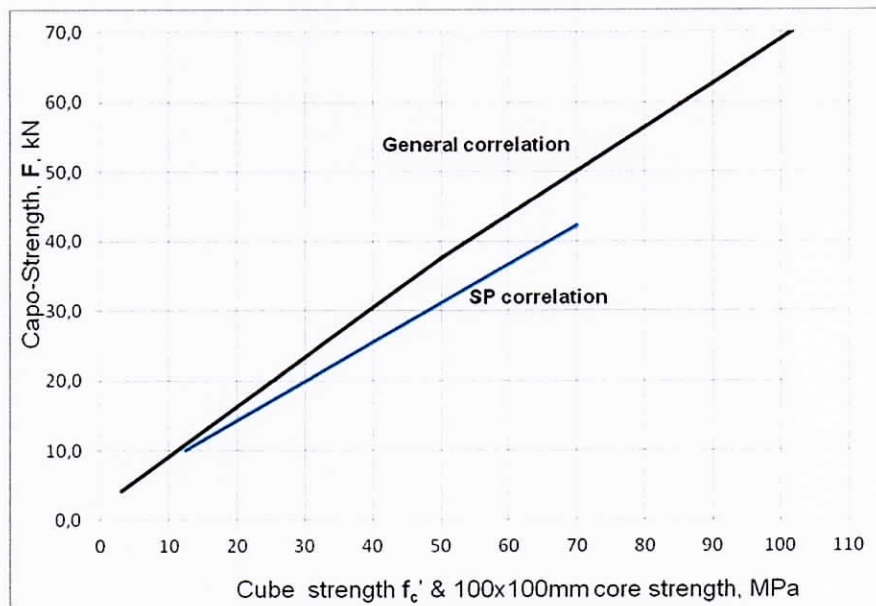

Figure 20. The correlation between Capo-Test and 100 mm x 100 mm cores, trimmed and air cured 3 days before testing, made by the National Swedish Testing Institute (SP) on 13 old Swedish bridges. The correlation is compared to the general correlation for standard cubes (figure 6).

The correlation by the National Swedish Testing Institute (SP) was found to be  $F = 0.55 f_{cc} + 3.16$ . The residual standard deviation measured was 4.1 MPa.

The difference between the Capo-Test measured at the 25 mm surface layer and the core strength 75-100 mm deep may be explained partly by the 3-day air-curing of the cores prior to crushing compared to curing 6 days in plastic bags or water as is the practice in other countries, and partly by actual different concrete qualities at the two depth levels.

Another reason could be relative low CAPO-Strength due to inappropriate plane surfaces for the 55 mm inner diameter counter pressure to rest against.

Similar comparisons from testing of 15-25 year old precast bridge girders in Pakistan and in Poland have, however, shown no significant difference between the "surface" strength and the strength of the "interior" of the concrete.

## 7. Conclusions

There is ample evidence to use general correlations for the Lok-Test and the Capo-Test systems to measure the strength of the coverlayer of reinforced concrete structures.

The general correlations are shown in figure 13 for 150 mm x 300 mm standard cylinder strength and in



figure 16 for 150 mm standard cube strength. The 95% confidence limits for an average of two reference tests (cylinders or cubes) and four Lok-Tests / Capo-Tests are well within plus/minus 3 MPa for a maximum aggregate size of 16 mm and plus/minus 4 MPa for 32 mm.

Compared to the general correlations, the three correlation examples illustrated in this paper produce strength estimates within 2%.

There is no reason to believe that the pullout force measured by Lok-Test is different from the pullout force measured by Capo-Test. Also the within-test variation and tile in-place test variation of the two test systems are of the same order as indicated in the figures 4, 5 and 12.

Should calibration tests to standard reference specimens need to be carried out, the procedures in section 2.1 of this paper - and detailed in (Petersen & Poulsen, 1992), in (Bickley, 1993), in (Carino, 1990) or in British Standard BS 1881: Part 207 - have to be adhered to, to ensure same concrete quality of the correlation specimens and proper statistical evaluation.

For on-site testing with the Lok-Test and the Capo-Test, guidance is given in the following publications:

*Timing of early form stripping, or otherwise timing of early loading operations, using, the Lok-Test, is detailed in (Kierkegaard-Hansen & Bickley, 1978), (Bickley and Fasullo, 1981), (Petersen & Hansen, 1982), (Bickley, 1982), (Bickley, 1984), (Petersen, 1990) and (Bickley & Hindo, 1994).*

For using the Lok-Test and the Capo-Test for quality control of the coverlayer of new structures, detailed information is given in (Petersen & Poulsen, 1994) and in (Bickley, 1993).

## Acknowledgement

The author would like to thank all the parties, that have participated with great enthusiasm and unselfishness in the development of the Lok-Test and the Capo-Test, establishment of the scientific background, in the validation of the methods and in bringing the systems "out there" for practical applications. It has been a very interesting journey! Not at least thanks to the persons, companies and institutions that supplied the correlations. Particular thanks to Peter Kierkegaard-Hansen for his brilliant ideas, to Herbert Krenchel for his constant and careful support and relevant investigations, to Niels Saabye Ottosen, who made us understand what was going on in a pullout test, to John A. Bickley for his Viking spirit in adopting the system and giving a full blast to its rightful application, and to Anker J. Hansen with his great ability to make the process enjoyable. Also thanks to Sal Fasullo, the best Lok-Test technician in the world, and to Ervin Poulsen for his clear and comprehensive statistical contributions.

## 7. References

- 1970 Krenchel, H.: "Lok-Strength testing of concrete", Report # S/69 1970, Structural Research Laboratory, Technical University of Denmark, Lyngby (in Danish)
- 1975 Kierkegaard-Hansen, P.: "Lok-Strength", Nordisk Betong, #3-4, 1977, Stockholm, Sweden
- 1976 Poulsen, P.E.: "Evaluation of concrete strength by drilled cores, Lok-Test, ultrasound, rebound hammer and cylinders", Report 75:64, Part 1-2, Nov. 1975, Building Division, Danish Engineering Academy, Lyngby (in Danish)
- 1976 Jensen, B. Chr. & Bræstrup, M.W.: "Lok-Test determine the compressive strength of concrete", Nordisk Betong, # 2, 1976, Stockholm, Sweden
- 1977 Bellander, U.: "Documentation of the strength in finished products", 3:77, The Cement and Concrete Institute (CBI), Stockholm, Sweden

- 1978 Kierkegaard-Hansen, P. & Bickley, J.A.: "In-Situ strength evaluation of concrete by the Lok-Test System", presented at the ACI Fall Convention, Oct. 29th - Nov. 3rd, 1978, American Concrete Institute, Detroit, USA
- 1980 Petersen, C. G.: "Capo-Test", Nordisk Betong, # 5-6, 1980, Stockholm, Sweden.
- 1980 Jensen, I.K.: "Secondary stress influence on the Lok-Strength", Special Paper, 1980, Institute of Buildings, University Center of Aalborg (AUC), Denmark (III Danish)
- 1981 Bickley, J.A. & Fasullo, S.: "Analysis of pull-out data from construction sites", Transportation Research Board, 1981, Washington DC, USA
- 1981 Ottosen, N.S.: "Nonlinear finite element analysis of pull-out test", Journal of the Structural Division, Proceedings of the American Society of Civil Engineers, Vol.107, No. ST4, 1980, USA
- 1982 Bickley, J.A.: "The variability of pull-out tests and in-place concrete strength", Concrete International, Vol.4, No.4, American Concrete Institute, Detroit, USA
- 1982 Krenchel, H.: "Lok-Strength and Capo-Strength of concrete", ABK publication, Serie I, No.71, 1982, Structural Research Laboratory, Technical University of Denmark, Lyngby (in Danish).
- 1982 Petersen, C.G. & Hansen, A.J.: "Pullout and maturity tests for early loading of structures", Proceedings, International Conference on Concrete at Early Ages, Vol. II, pp. 170-175, 6-8th April, 1982, RILEM, Pressess de l'Ecole Nationale des Ponts et Chausseés, Paris, France
- 1983 Bellander, U.: "Quality control of concrete structures", Nordisk Betong, # 3-4, 1983, Stockholm, Sweden
- 1983 Bungey, J.A.: "An appraisal of pull-out methods for testing concrete", Proceedings, International Conference on NDT, Engineering Technics Press, 1983, London, U.K.
- 1983 Stone, W.C. & Carino, N.J.: "Deformation and failure in large-scale pullout test", Technical paper No.80-46, ACI Journal, Nov.-Dec., 1983, pp. 501-513
- 1984 Petersen, C.G.: "Lok-Test and Capo-Test development and their applications", Proc. ICE, Pt. 1, 76, May 1984, pp. 539-549
- 1984 Yener, M. & Chen, W.F.: "On in-place strength of concrete and pullout tests", Cement, Concrete and Aggregates, Vol.6, No.2, 1984, pp. 96-99
- 1984 Bickley, J.A.: "The evaluation and acceptance of concrete quality by in-place testing", Special Publication SP 82-6, 1984, American Concrete Institute, Detroit, USA
- 1984 Bickley, J.A.: "Cost effectiveness of in-situ testing", presented at the General Session/ Research Sessions at the CANMET/ACI International Conference on In-Situ/Non-Destructive Testing of Concrete, Oct. 2-5th, 1984, Ottawa, Ontario, Canada
- 1984 Krenchel, H. & Petersen, C.G.: "In-Situ pullout testing with Lok-Test, ten years experience", presented at the General Session/research Sessions at the CANMET/ACI International Conference on In-Situ/Non-Destructive Testing of Concrete, Oct. 2-5th, 1984, Ottawa, Ontario, Canada
- 1985 Krenchel, H. & Shah, S.P.: "Fracture analysis of the pullout test", RILEM, Materials & Structures, No. 108, 1985
- 1985 Krenchel, H. & Bickley, J.A.: "Pullout testing of concrete. Historical background and scientific level today", Nordic Concrete Research, Publ. No.6, 1985, The Nordic Concrete Federation.
- 1988 Yun, C.H., Choi, K.R., Kim, S.Y. & Song, Y.C.: "Comparative evaluation of nondestructive test methods for in-place strength determination", SP 112-6, in ACI special publication SP 112, 1988, ACI, Detroit, USA

- 1988 Nasser, K.W. & Al-Manaseer, A.A.: "Nondestructive testing of hardened concrete in-place", University of Saskatchewan, Saskatoon, Saskatchewan, Canada.
- 1989 Bungey, J.H. & Millard, S.G.: "Testing of concrete in structures", 3rd edition, Blackie Academy & Professionals, an imprint of Chapman & Hall, Wester Cleddon Road, Bishopsbriggs, Glasgow G64 2NZ, U.K.
- 1989 Rockström, J. & Molin, C.: "Limited study of relationship between strength measured by rebound hammer, Capo-Test and drilled-out cores", SP-AR 1989:17, The Swedish National Testing Institute (Statens Provningsanstalt), Box 857, S-501 15 Borås, Sweden (in Swedish)
- 1989 ACI: "In-place methods for determination of strength of concrete", ACI 228.1R-89, American Concrete Institute, Detroit, USA
- 1990 Petersen, C.G.: "Testing of structures with Lok-Test and Capo-Test", Bygningsstatistiske Meddelelser, Vol. 61, No.2, 1990, Danish Society of Building Statics, Lyngby, Denmark (in Danish)
- 1990 Worters, P.: "In-Situ compressive strength testing of precast concrete tunnel lining, segments using Capo-Test", IST0041090-1, 2nd Nov. 1990, CMM, 3 Dukeswood, Chestfield, Whitstable, Kent CT5 3PJ, U.K.
- 1990 Carino, N.J.: "Statistical methods to evaluate in-place test results", RILEM, Testing during concrete construction, Chapman & Hall, ISBN 0-442-31389-6, 1990.
- 1990 Petersen, C.G.: "In-place testing for quality assurance and early loading operations with pullout testing and maturity measurements", RILEM, Testing during Concrete Construction, Chapman and Hall, ISBN 0-442-32389-6, 1990
- 1991 Malhotra, V.M. & Carino, N.J.: "Handbook on non-destructive testing of concrete", ISBN 0-8493-2984-1, CRC Press Inc., 2000 Corporate Blvd., N.W., Boca Raton, FL. 33431, USA
- 1992 CIRIA: "Testing of concrete in structures, a guide to equipment for testing concrete in structures", TN 143, 1992, the Construction Industry Research and Information Association, 6 Storey's Gate, Westminster, London SW1P 3AU, U.K.
- 1992 Petersen, C.G. & Poulsen, E.: "Pullout testing by Lok-Test and Capo-Test with particular reference to the in-place concrete of the Great Belt Link", 1992, Danish Concrete Institute A/S, Bredevej 2, DK-2830 Virum, Denmark
- 1993 Bickley, J.A.: "Field manual for maturity and pullout testing on highway structures SHRP-C-376, 1993, Strategic Research Highway Program, National Research Council, Washington DC, USA
- 1994 Bickley, J.A. & Hindo, K.R.: "How to build faster for less - the role of in-place testing in fast track construction", presented at the ACI Spring Convention, 1994, American Concrete Institute, Detroit, USA
- 1994 Yener, M.: "Overview and progressive finite element analysis of pullout force", ACI Structural Journal, 91, No. 1, Jan./Feb., 1994, pp. 49-58

**Standards covering Lok-Test and Capo-Test:**

ASTM C 900-99: "Standard Method for Pullout Strength of Hardened Concrete", ASTM Committee on Standards, 1916 Race Street, Philadelphia, Pa. 19103, USA

British Standard BS 1881: Part 207, "Testing concrete, recommendations for the assessment of concrete strength by near-to-surface tests", British Standard Institution, 2 Park Street, London W1A 2BS, U.K.

European Standard: "Testing concrete in structures- Part 3: Determination of pull-out force", EN 12504-3, European Committee for Standardization, Central Secretariat, rue de Stassart 36, B- 1050 Brussels, Belgium

**Standards covering Lok-Test:**

Danish Standard DS 423.31: "Betonprøvning, hærdnet beton, udtræksprøvning", Dansk Standardiseringsråd, Copenhagen, Denmark

Swedish Standard SS 13 72 38: "Betonprovning hårdnad beton - utdragsprov", SIS Standardiseringskommisionen i Sverige, Stockholm, Sverige

Norwegian Standard NS 3679: "Betonprovning, herdet betong, uttreksprøvning", Norges Byggstandardiseringsråd (NBR), Oslo, Norway

ASTM C 900-82: "Standard Method for Pullout Strength of Hardened Concrete", ASTM Committee on Standards, 1916 Race Street, Philadelphia, Pa. 19103, USA

DIN ISO 8046: "Festbeton - bestimmung der ausziehfestigkeit", DIN Deutscher Institut furr Normung, Beuth Verlag GmbH, Burggrafenstrasse 6, 1000 Berlin 30, Deutschland.